

CF-60W/120W



CORNER SPEAKER



FEATURES

- Cover the demands of various sound system operation in every venues
- Compact arrays for wide dispersion angles (90°~360°)
- Heatproof tweeter by inserting ferro-fluid in the gap of neodymium magnetic circuit
- 1" P.E.I. titanium coating diaphragm & light cone paper body woofer with foaming urethane resin for better sound reproduction.
- Impedance loudspeaker networks
(CF-60W: 8Ω/166Ω/333Ω/666Ω, CF-120W: 8Ω/83Ω/166Ω/333Ω)

SPECIFICATIONS

■ ELECTRICAL

	Unit	CF-60W	CF-120W	
Rated Input	W	60	120	
Maximum Input	W	100	150	
Frequency Response	Hz	150~18k	150~18k	
Impedance	Ω	8, 166, 333, 666	8, 83, 166, 333	
SPL	1m/W	dB	90	90
HF Drive	Inch	1"	1"	
LF Drive	Inch	5 1/4"	5 1/4"	
Cross-Over Frequency	Hz	2.5k	2.5k	
Dispersion	Angle	120°(H) x 90°(V)		

* Choosing Impedance Selector Switch
Adjust the switch to "Low" side when using for Low impedance(8ohm) application, and adjust the switch to "high" side when using for high impedance(100V) application.

■ GENERAL

- WeightCF-60W: 2.7kg/6lb
CF-120W: 3.2kg/7lb
- Dimensions226(W) x 327(H) x 163(D)mm
8.9(W) x 12.9(H) x 6.4(D)in

CF-60W/120W

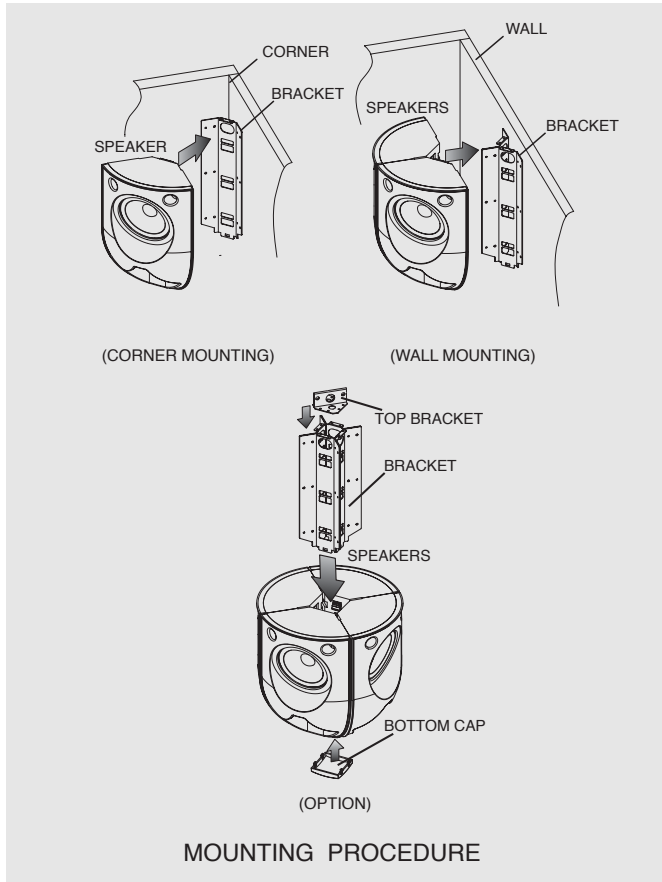

POLAR PATTERN DIAGRAM

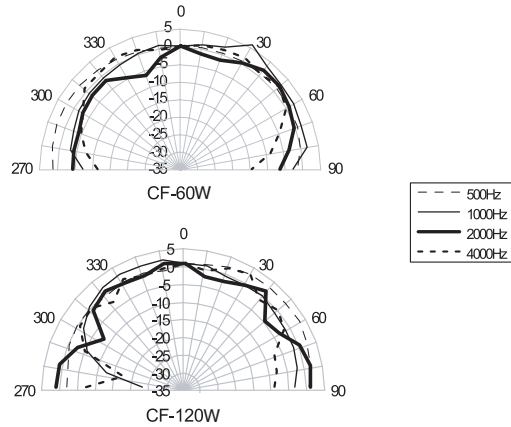

MATCHING TRANSFORMER

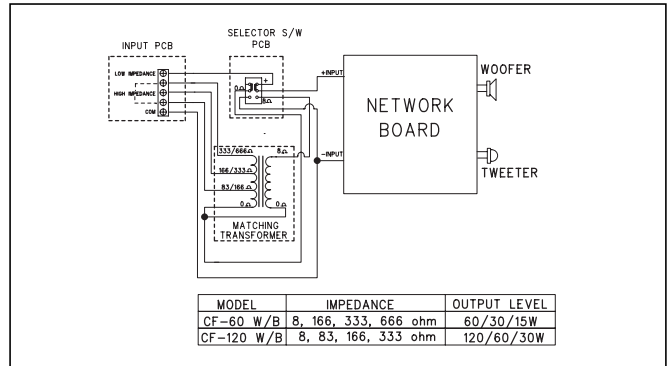

FREQUENCY RESPONSE

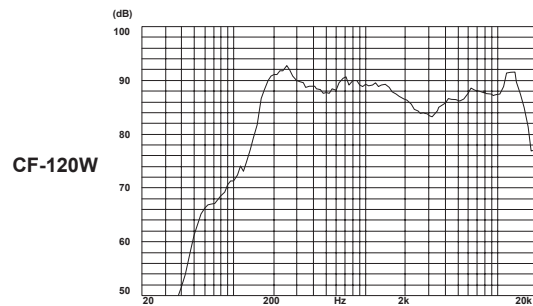
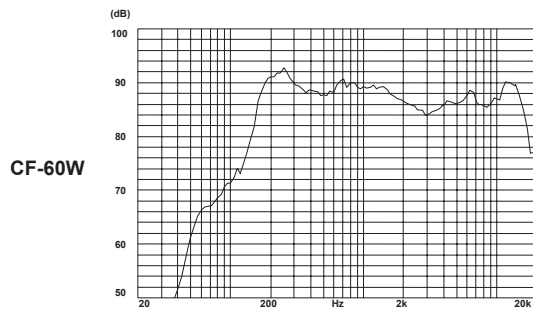

IMPEDANCE

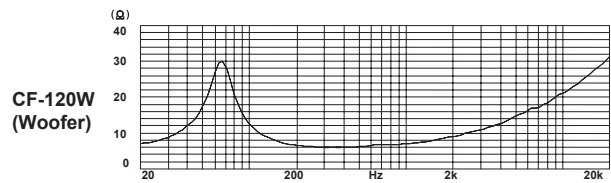
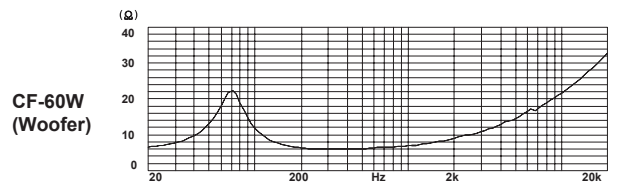
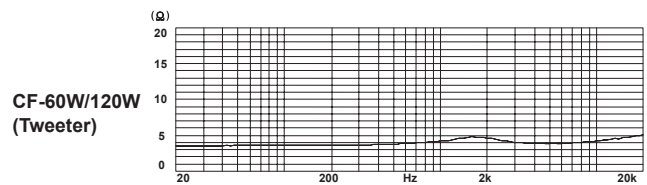

interM

OFFICE : 653-5 BANGHAK-DONG, DOBONG-KU, SEOUL, KOREA TEL : 82-2-2289-8140~8, FAX : 82-2-2289-8149

Home page : <http://www.inter-m.com>

E-mail : export@inter-m.com

9027701212